

High-Mix CNC Automation

Unleash the Full Potential of Your Manufacturing



Why Fastems?

The mission of Fastems is your success in automated high-mix manufacturing.

By revolutionizing shop floor operations, automation enables significant financial results and builds the key business KPIs. That's what more competitive manufacturing looks like.

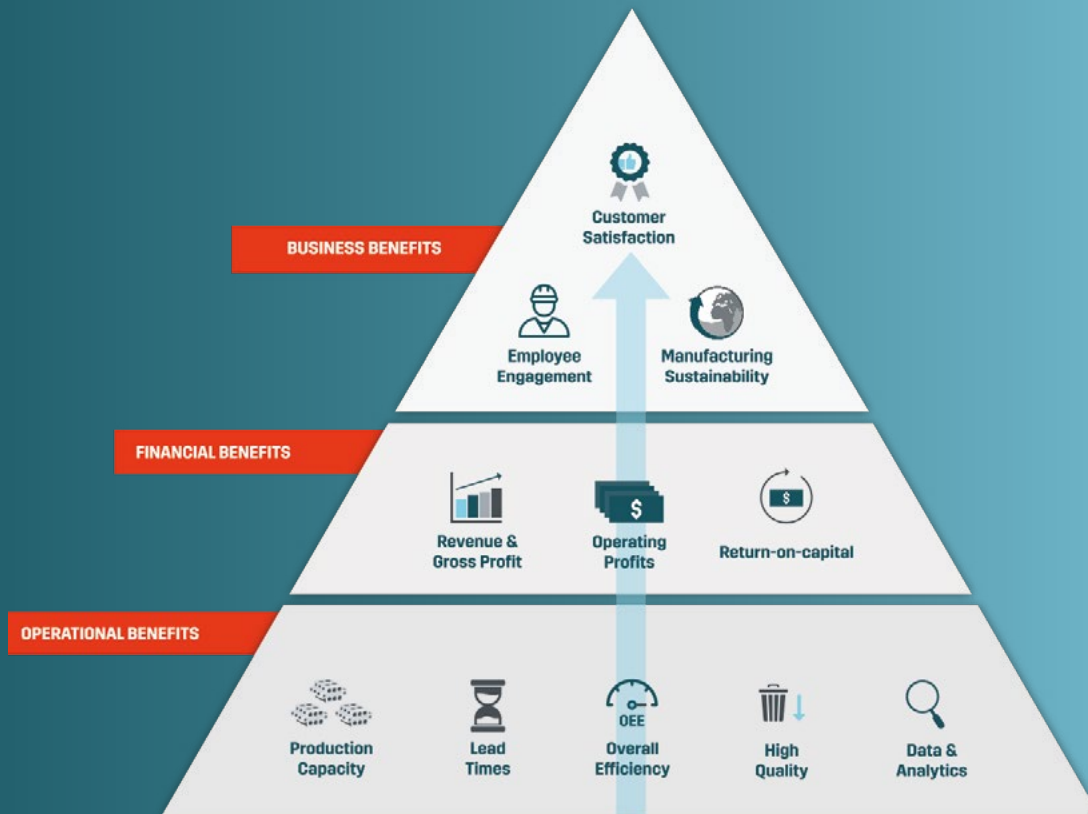

Recipe for Automation Success

Our decades and thousands of systems worth of automation experience suggests that just placing a robot in front of a CNC machine does not 'automatically' help. Instead, here's our four-step recipe for automation success.

1 IDENTIFY AND SOLVE THE RIGHT PRODUCTION ISSUES

Your CNC machines are not what defines your automation needs - it is your production challenges and goals that do! Our approach is to uncover those challenges and goals with you and build a solution that truly fits.

2 ENJOY THE BENEFITS OF WORLD-LEADING HIGH-MIX AUTOMATION

Today's high-mix automation is capable of so much more than just 'moving parts'. Fastems world-leading control software MMS, unique integration capabilities for over 100 machine or device brands, and wide automation offering help you to become an automation champion.

3 WORK WITH A PARTNER YOU CAN TRUST

Fastems' story began in 1901 and the last 120 years signify an ascent from an expert in machining, machine building and special machine tools into a global leader in high-mix manufacturing automation. It's one thing to render a picture of an automation system: we have delivered over 5,000 of them during the past four decades to world-leading OEM manufacturers such as Lockheed Martin, BAE Systems, Wärtsilä, AGCO corporation, ABB, as well as a lot of forward-looking machine shops all over the world.

4 MAKE A LONG-LASTING INVESTMENT

To reach the full potential of your automated production for decades to come, a full-stack service partner is required. Fastems' over 130 automation service specialists ensure you reliable and efficient manufacturing operations 24/7, provide system and software updates, and support you with system training.

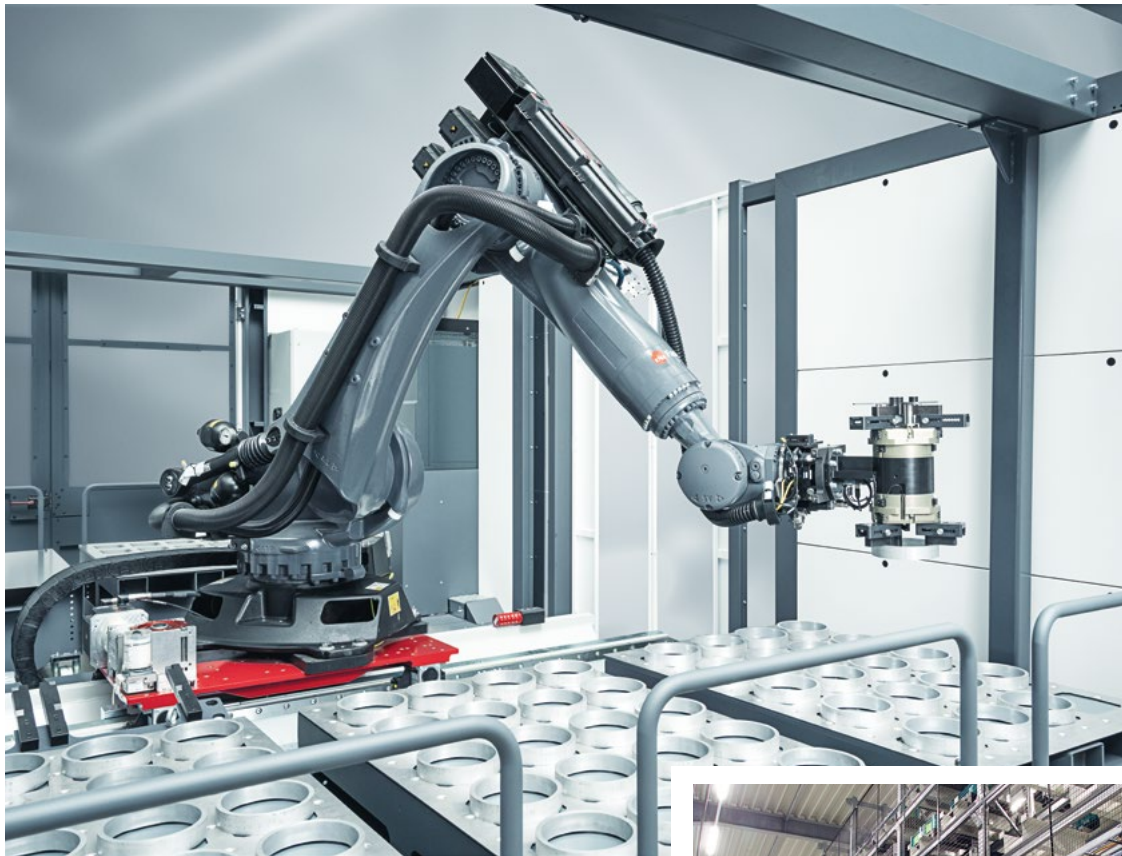

FASTEMS AT A GLANCE:

40+ years of CNC automation / pioneering manufacturing technology for more than **120** years / over **550** employees / integration for over **100** different machine brands / core business in automation with **5,000** systems worldwide / **8,000** yearly spindle hour record.



Rethink CNC manufacturing

Reach Your Full Potential

Your company is different from any other. You have your own machinery setups, systems, manufacturing processes and ways of doing things.

However, you are likely to share similar challenges and ultimately the same goal with others: to be in control of your production, utilize your capacity well and deliver the required quality on time.

THE FORMULA IS SIMPLE:

Our automation helps you do the right things at the right time – all the time.

Helping you get the most out of your production machines. Improving your lead times and consistency of quality, minimizing waste and delays in your processes.

Optimize Inefficiencies Eating Your Spindle Time

An average unautomated machining center cuts chip at 20 % or at very best at 40 % of time. Here are the inefficiencies eating your spindle time - with automation you can solve them all.

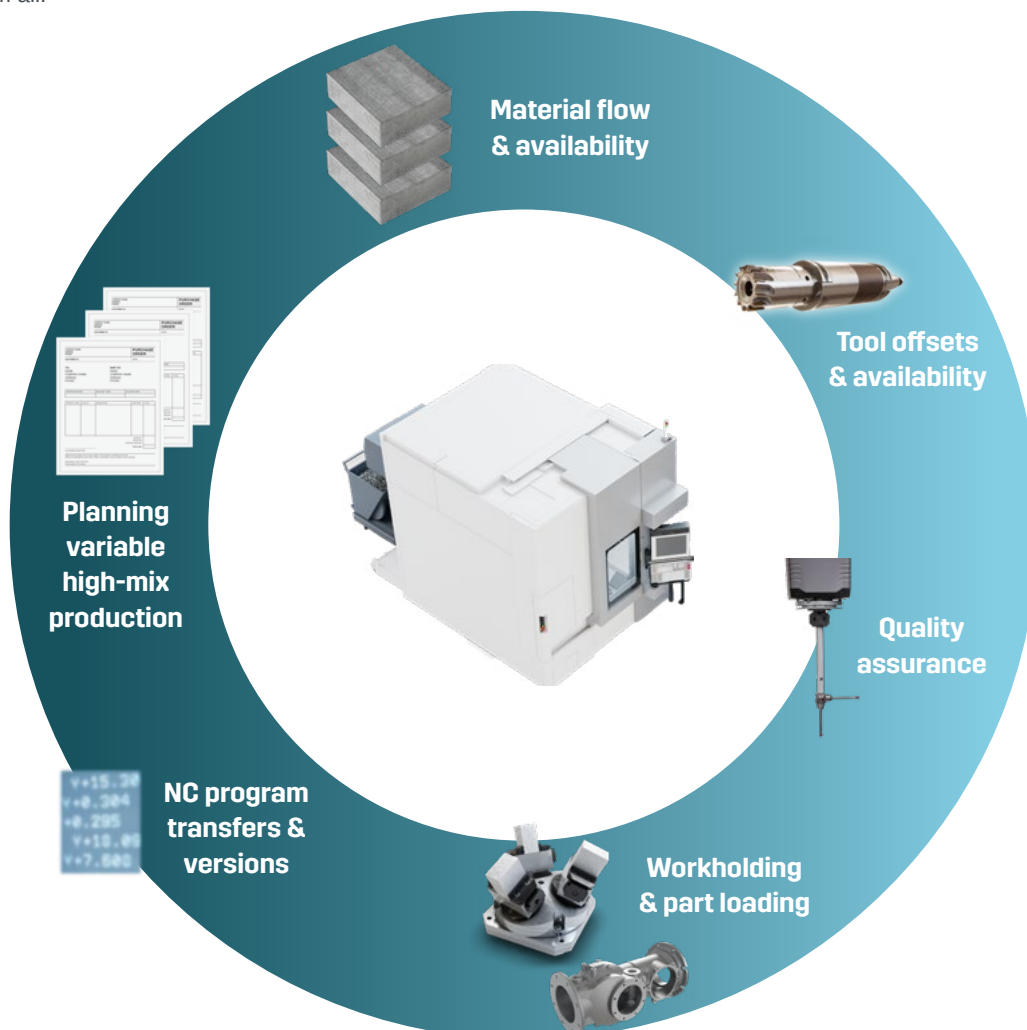

Improve the Right Numbers

Improvement in these numbers reduces costs and increases efficiency and revenue.

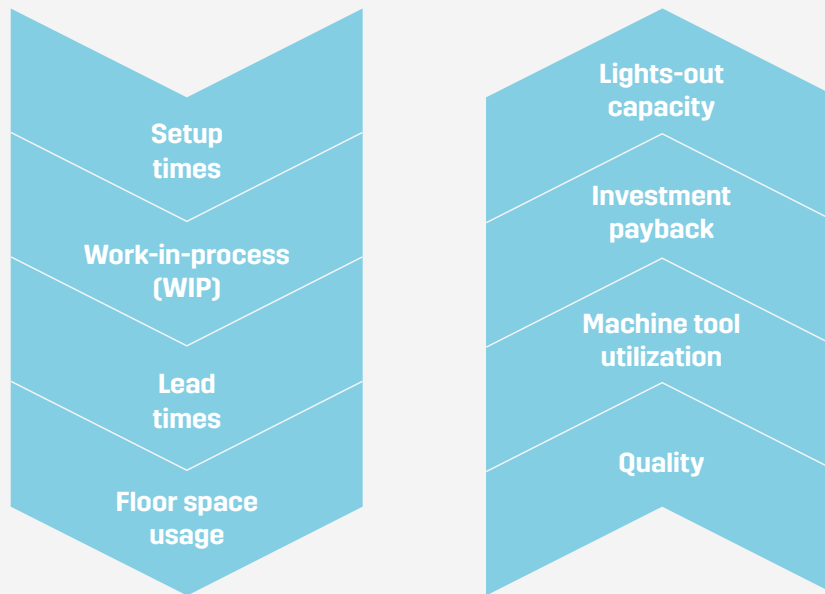

You don't need large production volumes to gain the benefits of automation. It makes perfect sense from a batch of one to a batch of thousands.

Rethink Productivity Through Automation

	no automation	with automation
Investment cost 3 machine tools *	1,200,000 €	1,200,000 €
Investment cost automation	0 €	600,000 € **
Machine tool utilization rate	40 %	85 % ***
Machining hours/year ****	4,800 h	15,300 h
Total income per year (machining selling price 100 €/h)	480,000 €	1,530,000 €

What are your production needs?

- * calculated with three 5-axis HMCs
- ** includes automation, 18 pallets and machine tool modifications
- *** unmanned night shift + no spindle time loss due manual setup changes
- **** 50 weeks, 5 days per week, 2 manned shifts (+ 1 unmanned with automation) per day

Manufacturing Management Software MMS

Master Your High-Mix Manufacturing

WHAT IF

... you could always produce only and exactly what your customer ordered?

▶ Deliver it precisely when needed, reliably at the right quality and price?

... you could erase all unnecessary manual intervention from the process?

▶ And give people the resources to be more productive and motivated at work?

... you could multiply your production capacity and utilization rate of your machine tools?

... you had no more scheduling problems?

▶ And no delays due to missing tools, urgent orders and unexpected machine stops?



... you had real-time visibility for material stock?

▶ And materials were automatically delivered when needed?

No More 'What If's!

Fastems Manufacturing Management Software is like no other on the market. It is the brains and nervous system of truly intelligent factory automation.

MMS UTILIZES REAL-TIME DATA AND FEATURES:

- Predictive scheduling
- Adaptive production planning
- In-advance warnings on missing resources
- Visibility over whole production with KPI reports

Predictive scheduling adapts to all changes caused by e.g. missing tools, urgent orders, unexpected machine stops, and incorrect NC program revisions.

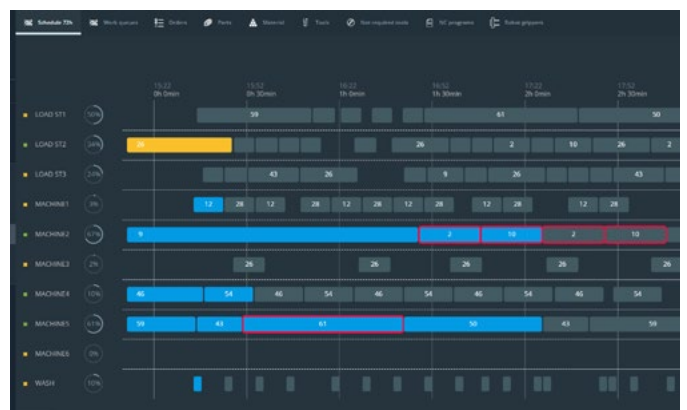



What Is MMS?

MMS is the control software of Fastems automation solutions – planning, running and monitoring high-mix manufacturing. Once MMS has your part data and customer orders, it manages and schedules your manufacturing automatically in one place!

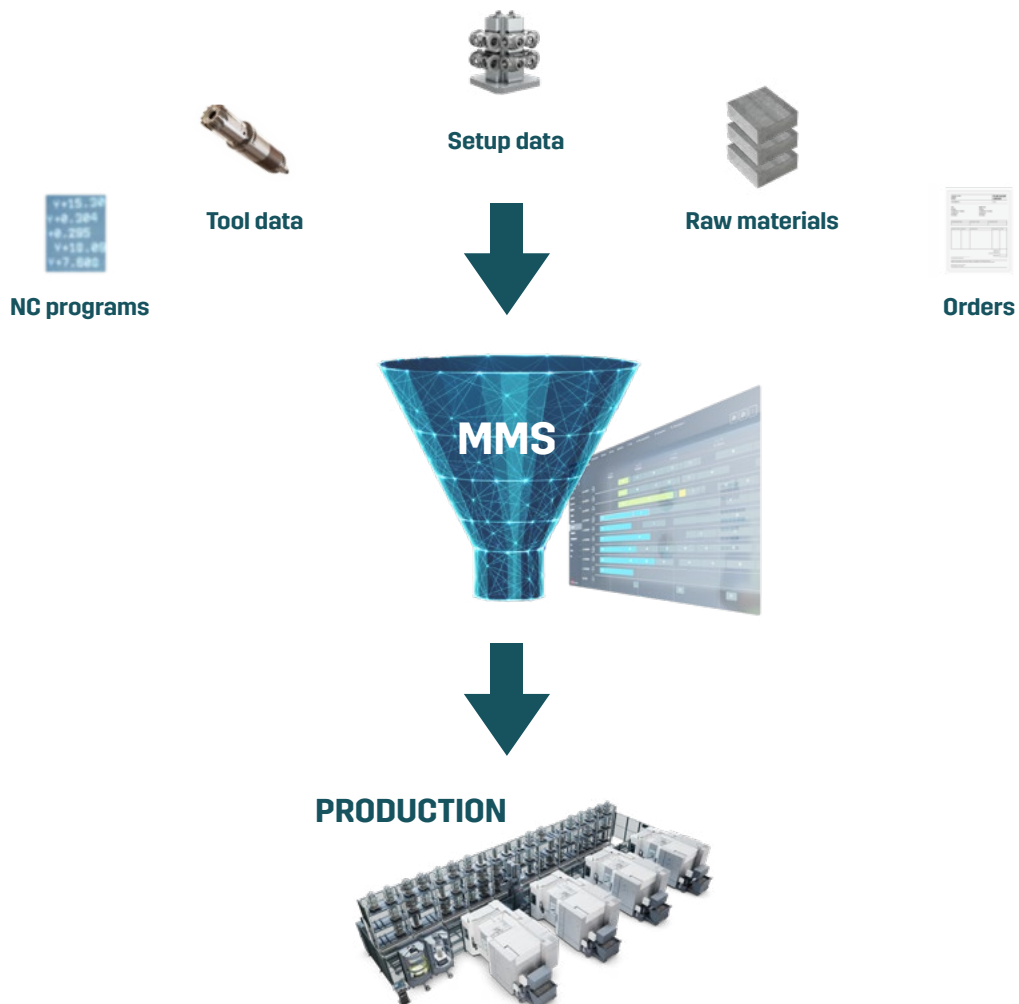

How is MMS different?

Plan, Run and Monitor Your Production

	Typical CNC automation	Automation run by MMS
Plan		
PART DATA	Knows pallets, NC programs, tooling and routing for each pallet.	Knows drawings, workholding, NC programs, tools, raw material, operator instructions and routing for each part.
ERP INTERFACE	No	Yes – fetches production orders and deadlines automatically in real-time.
RESOURCE CHECK	Checks pallet / workholding and available CNCs.	Checks pallets / jaws / workholding, tools, available CNCs, NC programs and raw material, and reports shortages in advance.
PRODUCTION SCHEDULING	FIFO	Just-in-time.
Run		
OPERATOR GUIDANCE	The next workpiece / pallet to load.	In-advance guidance to prepare materials and other resources for several jobs for long unmanned manufacturing.
CHANGE MANAGEMENT	Manual / reactive	Production plan updates automatically based on real-time production order and available resource information.
OTHER PROCESS INTEGRATION	No	Yes – i.e. material storage, tool automation, finishing, marking, washing, CMM, surface treatments, AGVs, custom robotic applications,...
Monitor		
PRODUCTION TRANSPARENCY	Cell-level	System-level. Real-time device statuses and activities also remotely available for connected users at myFastems digital service.
KPI MONITORING	Cell-level	Automatic system-level reporting with over 50 KPI options.
DATA-BASED PRODUCTIVITY DEVELOPMENT	No	Automatic productivity-enhancing tips based on production data. Possibility to export the collected production data to Excel or another reporting tool.

Where can you use MMS?

Master Different Machining Operations

Milling and mill-turn MCs MMS Milling Automation

For handling pallets and zero-point plates.

Pallet transfers carried out by a stacker crane or a transfer robot.

TYPICAL APPLICATIONS

- Machining centers - with or without automatic pallet change
- Robotic deburring cells
- Automated machining pallet loading cells



Multi-tasking lathes MMS Turning Automation

For robotic part handling applications where parts are loaded directly into the machine tool or other device.

Possibility for automated setup changes.

TYPICAL APPLICATIONS

- Turning centers
- Measuring devices, washing machines, other devices



Stand-alone operations MMS Work Cell Operations

For managing capacity, work queues and resources of the standalone machines and manual work cells.

Can be used as a standalone solution or together with Milling or Turning automation.

TYPICAL APPLICATIONS

- Stand-alone-machine tools
- Quality and inspection operations

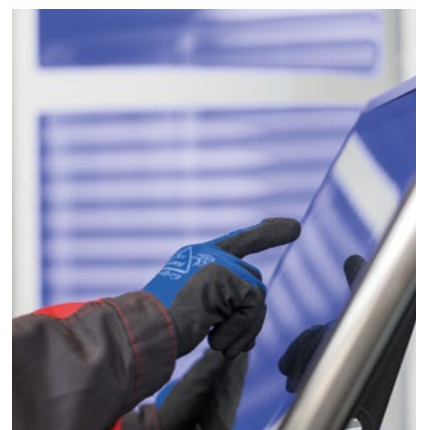

Different domains can be brought together, enabling factory-wide:
FINE SCHEDULING – RESOURCE MANAGEMENT – MONITORING

Fastems Services delivers

Full Support for Full Lifecycle

The mission of Fastems services is your success in automatic CNC manufacturing. The best automation comes with the best services, enabling predictive and efficient operations, system updates and modifications and your growth as an automation expert.

“Services are the differentiation nowadays. I need a helping partner not just in the sales phase but throughout the whole lifecycle. And I found them in Fastems.”

Production Manager, Sistag (Switzerland)
www.fastems.com/case/sistag-ag/



“The service agreement ensured us to be at the forefront of continuous software development and quick availability of new features.”

Quality Manager, Joensuun CNC Machining (Finland)
www.fastems.com/case/joensuun-cnc-machining-2/

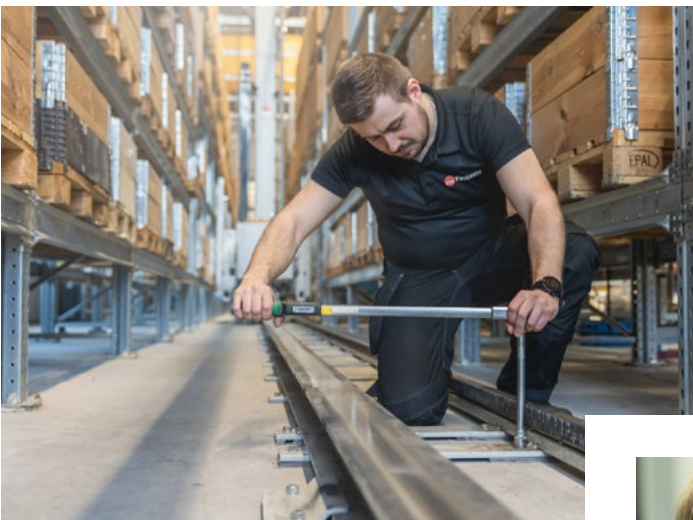

FASTEMS SERVICE IN NUMBERS:

4.5/5 in customer satisfaction

+80% of customers extend their systems

+90% of support tickets resolved remotely

40 years record of system use

Our Services for

Your Automation Success



OPERATE

Ensure the reliability and performance of your Fastems system.

- Genuine spare parts
- Field services
- Remote support
- Service level agreements
- Software maintenance

ADAPT

Adapt and update your Fastems system throughout their lifecycle.

- Extensions
- Modernizations
- Relocations
- Upgrades
- Software services
- Optimization services

DEVELOP

Get training and support to become an automation champion.

- Trainings
- Digital services for utilizing data power and potential

Make a long-lasting investment

Our Automation Grows with Your Business

Modernizations

Enjoy a lifespan of up to decades by updating the critical parts of your system.

Extensions & modifications

Add new devices, additional machine tools and storage places.

Relocations

Move your system into a new facility or within a facility.

Software upgrades

Add new software capabilities like ERP or PDM interface for higher productivity. Update your MMS for exciting features and extended lifetime.

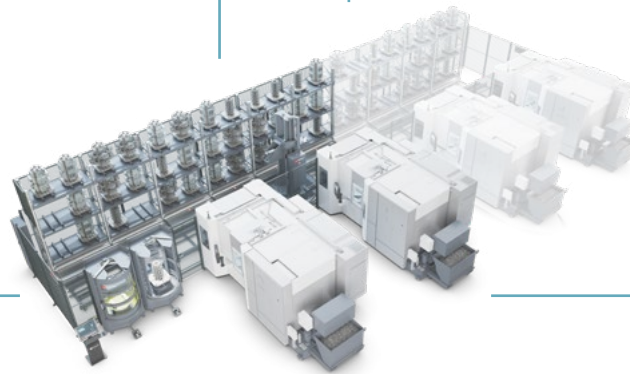

24/7 Technical Support

- Service engineers in multiple languages
- 90% of cases solved remotely, saving time and costs
- In-depth trouble-shooting via remote desktop connection
- Easy access to case progress information

Fastems Spare Parts

- Get the right parts for your system quickly and easily
- 12-month warranty
- Flexible delivery globally
- Express shipment option

Software Services

- Software agreements: benefit from continuous improvements and compatibility updates
- Improved system security and compliance
- Optimizing and enhancing software capabilities, keeping you competitive in the long run

Your Digital Service Platform

myFastems

Take your manufacturing digitalization to the next level with myFastems! myFastems is a service platform for easier and more effective use of Fastems automation. You can access myFastems via PC, phone or tablet, anywhere at anytime. myFastems requires MMS version 6 or newer - for older versions, we recommend updating your MMS.

myFastems is free for Fastems automation users.

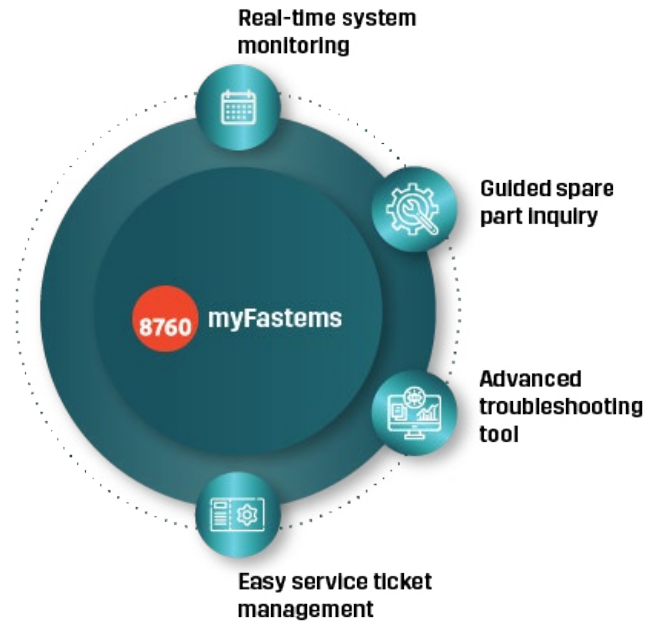

Key Benefits

Full visibility

- Real-time information - anywhere, anytime
- Conveniently track system KPIs (automation index, machine tool and device utilization, MTBF, MTTR) for continuous improvements

Fast support

- Increase system runtime with our 24/7 support
- Create support requests based on alarm data

Advanced insights

- Root-cause analysis of alarms
- First-aid tips for easy problem-solving with comprehensive insights

Transparent service

- Access service history effortlessly
- Guided spare part inquiries with smart recommendations

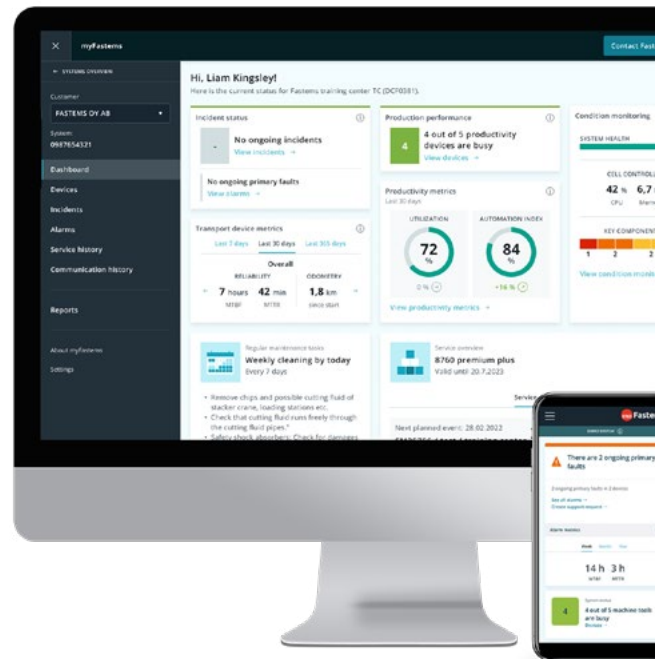

Upgrade to myFastems Performance

Extensive Reporting Capabilities

Take a leap instead of a step: myFastems Performance offers individual and customized reports on system performance, including improvement suggestions. Price list applies, consult your local Fastems representative.

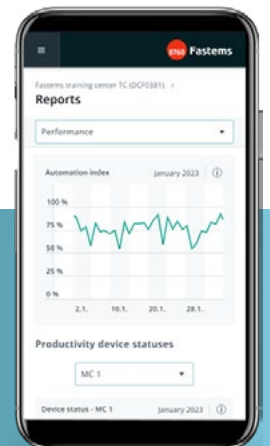

Learn more at:
myfastems.com



Experience Fastems offering virtually: fastems.com/living-factory/

Fastems Automation Systems Solution for Your Need

Fastems' industry-leading portfolio of automation systems offers the right solution for practically any need a machine shop might have. We provide you with highly flexible and process-safe solutions for any workpieces and batch sizes.

MILLING AUTOMATION

Fastems supplies automation for pallet and zero-point plate machines tools in payloads of 50 – 10,000+ kgs.

These are typically 3-5 axis milling machines, machining centers, grinding machines or vertical turning machines. We offer everything from small modular systems for a single machine tool to large tailored solutions with 10+ CNC machines of different kind.

TURNING AUTOMATION

Fastems supplies part handling automation systems in payloads of 1 – 500+ kgs.

Typical automated CNC machines are single or dual spindle lathes, turn/mills, 5-axis milling machines, grinding or honing machines and more. We offer smaller systems for 1-2 lathes all the way to complex agile manufacturing systems with 10+ machines.

DEVICE & SOFTWARE INTEGRATION

Integrating more processes and devices can increase the total productivity and quality.

Fastems integrates and automates measuring, washing, marking, finishing and various other devices or processes to be part of our intelligent CNC automation systems. We also offer deburring and robotic finishing cells and robotic systems for automated part loading to/from pallets.

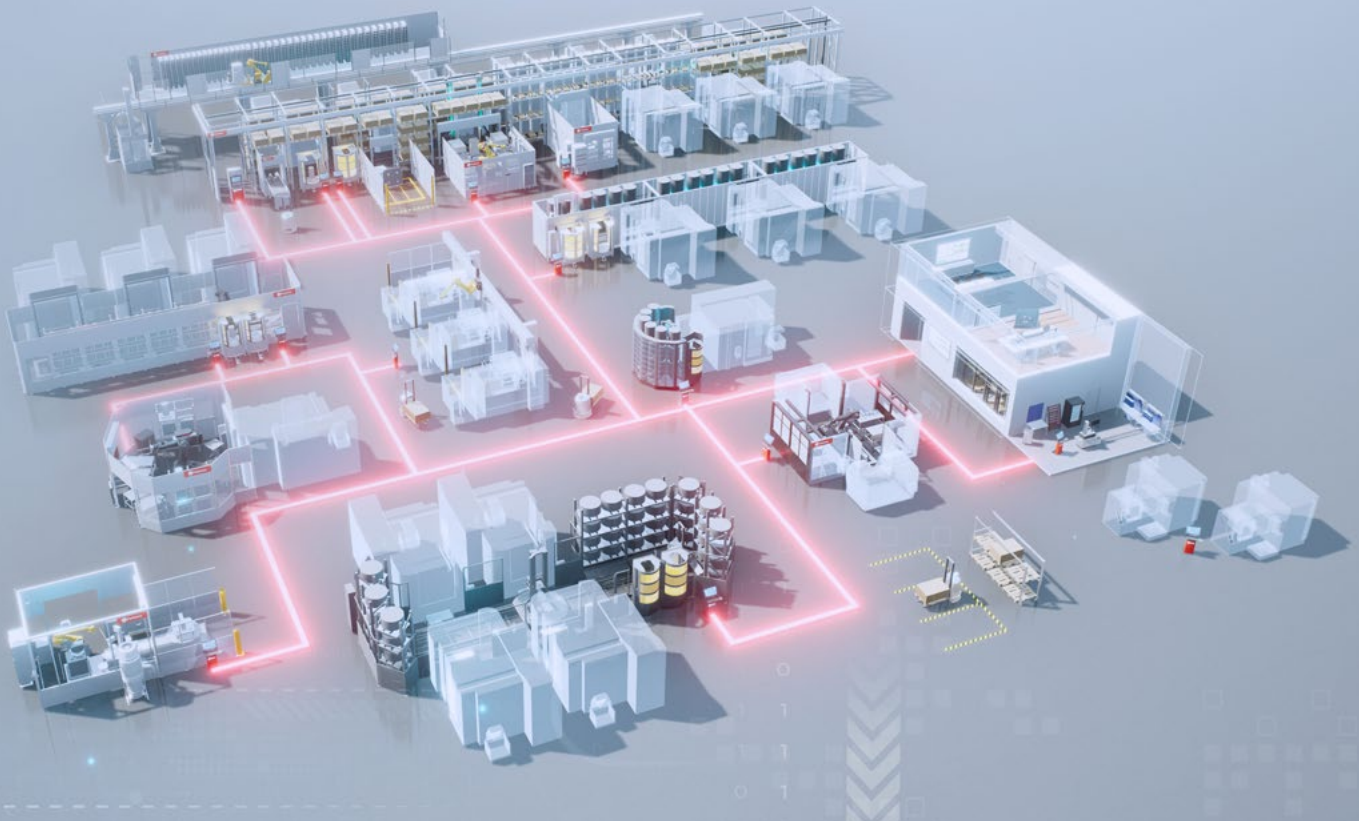



Product category —

Tool automation —

Other processes —

Payload —

Find out more: fastems.com/offering/automation-systems/

What would you like to automate?

Find the Right Solution

Fastems automation solutions are suitable for diverse production needs, scaling up from simple standalone work cells to highly advanced automated production systems.

Whatever your manufacturing set-up, we have the right Fastems system to make it more productive and more profitable for your business.

MAIN CATEGORY	PRODUCTS
Manual operations	MMS Work Cell Operations
3, 4 or 5 Axis Milling (APC*)	FPT Flexible Pallet Tower FPC Flexible Pallet Container FPS Flexible Pallet System MLS Multi Level System
4 and 5 Axis Milling & Mill-Turn (no APC*)	FPT Flexible Pallet Tower FPS Flexible Pallet System RoboFMS
Turning & Turn-Mill	AMC Agile Manufacturing Cell AMS Agile Manufacturing System
Other processes	CTS Central Tool Storage GTS Gantry Tool Storage TSC Tool Service Cell RFC Robotized Finishing Cell ALD Auto Loading Cell Other auxiliary processes

* APC – automatic pallet changer

MMS Work Cell Operations (WCO)

Automation Beyond Machine Tending

With the **Work Cell Operations (WCO)**, it's possible to bring all familiar MMS benefits and functionalities to manual manufacturing operations and stand-alone machines.

The software has flexible connection and integration options that enable combining various different non-automated and automated equipment under same control – including any Fastems automation that you might have.

WCO BENEFITS

- Automatic production scheduling based on real orders
- Prioritized work lists
- Resource need calculations
- Material flow management
- Different levels of machine interface functionalities

Order	Part	Operation	Qty	Ready	WIP	Scrapped	Setup	Material	Programs	Tools
5879455	DDX45551 Drill shaft	20 Turning	10	5	5	0	OK	40 / 10	OK	OK
5879455	DDX45551 Drill shaft	20 Turning	10	0	0	0	Start at 11:04	OK	40 / 10	OK
5879455	DDX45551 Drill shaft	20 Turning	10	0	0	0	Start at 17:14	OK	40 / 10	OK
5879455	DDX45551 Drill shaft	20 Turning	10	0	0	0	Start at 23:24	OK	40 / 10	OK
5879455	DDX45551 Drill shaft	20 Turning	10	0	0	0	Start at 17:04/2020	OK	40 / 10	OK
1562455	PDX13301 Shaft assembly frame	20 Turning	50	0	0	0	Start at 17:04/2020	OK	0 / 30	Not OK
1562455	PDX13301 Shaft assembly frame	20 Turning	50	0	0	0	Start at 18:04/2020	OK	0 / 30	Not OK
1562455	PDX13301 Shaft assembly frame	20 Turning	50	0	0	0	Start at 19:04/2020	OK	0 / 30	Not OK
1562455	PDX13301 Shaft assembly frame	20 Turning	50	0	0	0	Not scheduled	OK	0 / 30	Not OK

“WCO has brought transparency into our production: as a door-to-door MES solution, it helps us in identifying and tackling our production bottlenecks, and puts focus on the right things in order to excel in delivery performance.”

Production Manager
Sandvik Mining and Construction



Stand-Alone Operations



Product category —

Tool automation —

Other processes —

Payload —

Find out more: fastems.com/work-cell-operations/

Example of WCO managing a workshop production flow based on orders from ERP.

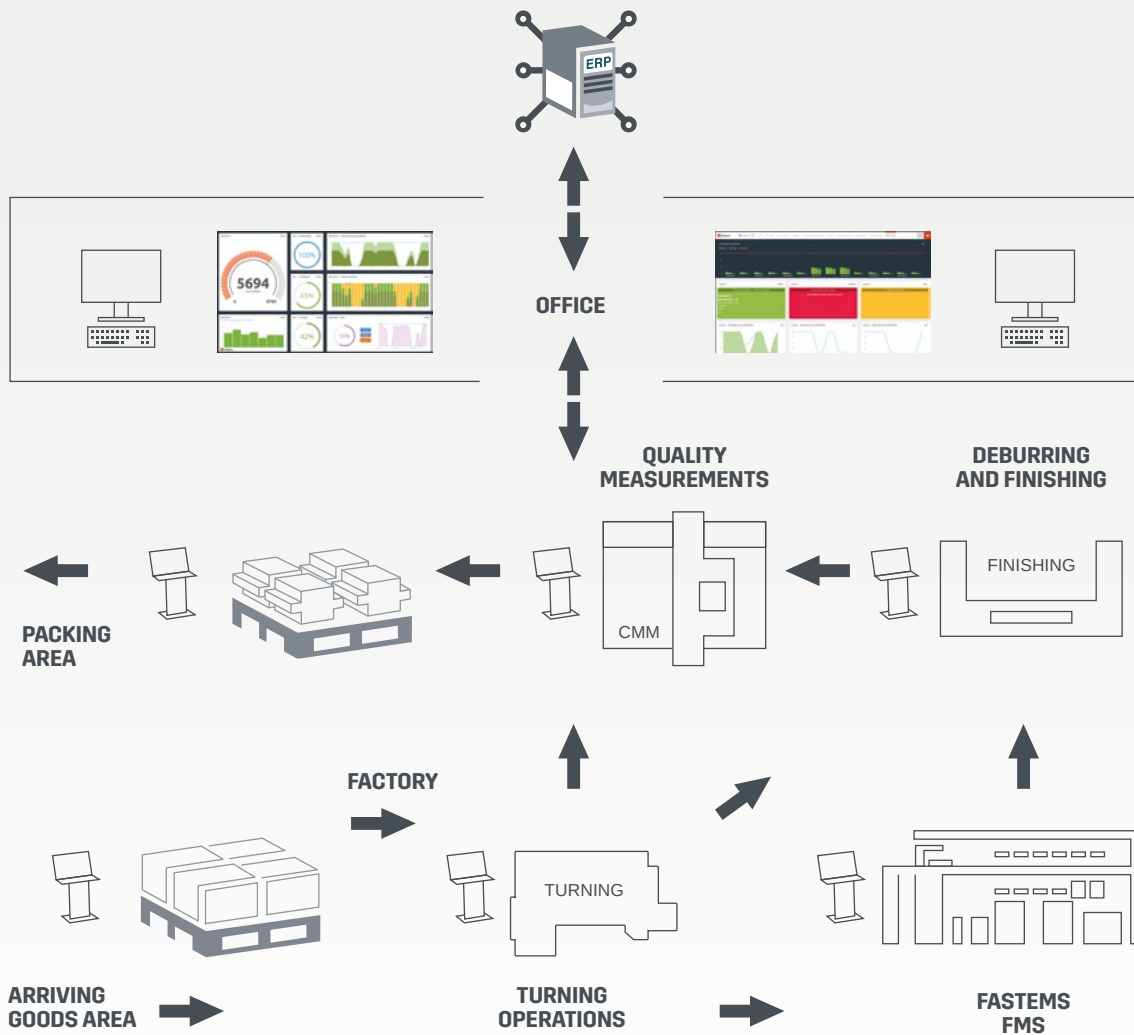

COMPLEMENT YOUR MOM SYSTEM WITH MMS WCO

The MMS WCO can be integrated to a wider MOM system and provide an excellent and comprehensive production planning and execution program that complements the overall software architecture of your company. Fastems has wide integration capabilities to many ERP and other IT systems that are usually at the core of MOM architectures.

MOM projects are evaluated case by case, so true connectivity and suitability are reviewed together with Fastems and your IT personnel.

FPT – Flexible Pallet Tower

Compact CNC Automation for 4 and 5 Axis



FPT is a compact pallet automation for a single machine tool with or without an automatic pallet changer (APC). FPT features a height configurable 2 to 4 level storage for up to 24 pallets, allowing also for two load heights in one system.

BENEFITS:

- Fast delivery and plug-and-play installation for 90+ machine tool brands
- Higher machine utilization and extended lights-out production capacity
- Compact footprint with configurable storage for 300-630 mm pallets
- Single-view user interface with drag-and-drop production order

- FPT-500
- FPT-1000

- 1 Pallet manipulator**
 - Pallet transportation
- 2 Pallet storage**
 - Configurable from 2 to 4 levels
 - Ask for two load heights optimization!
- 3 Cell Controller**
 - Touch operating panel
 - Ergonomic with adjustable height
- 4 Loading station**
 - Ergonomic operation
 - Clamping and unloading the parts
 - At a glance system status
- 5 Machine tool**
 - With or without automatic pallet changer
 - 300 to 630 mm pallets
 - Over 90 brands already interfaced with Fastems

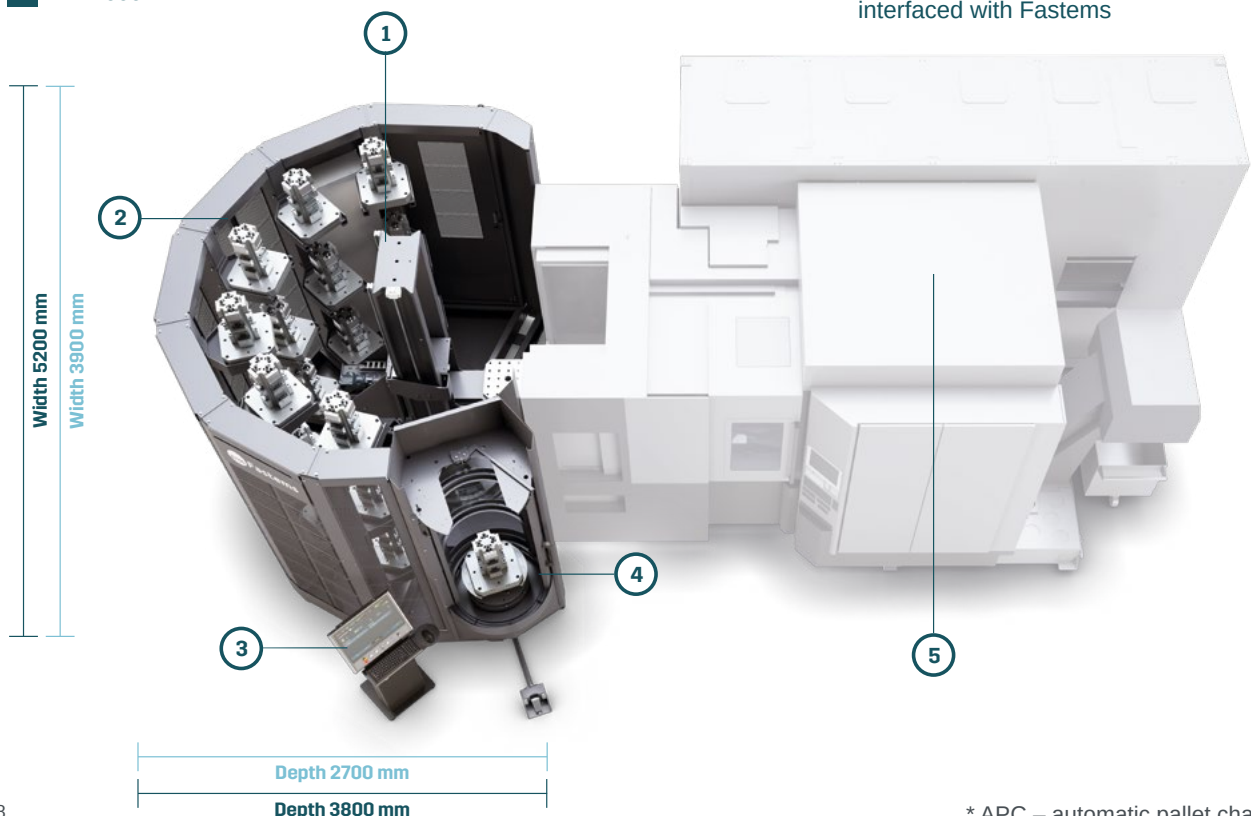

Milling (APC*/ no APC*)



Product category
Milling

Tool automation
No

Other processes
No

Payload
500–1,000 kg

Find out more: fastems.com/product/fpt/



“We can fit 18 pallets in 9 square meters, and keep our machine fed efficiently.”

CEO at Alfa Kvalitetslego
<https://www.fastems.com/case/alfa-kvalitetslego/>

Plug-and-play automation for 300-630 mm pallets



FPC – Flexible Pallet Container

Easy & Extendable Pallet Automation

A compact and versatile Flexible Pallet Container for 1 to 3 machine tools is fast to deploy, easy to use and can be extended cost-efficiently.

WHY CHOOSE FPC OVER JUST AN AUTOMATIC PALLET CHANGER OR A PALLET POOL?

- Run various parts with all machines
- 1 operator can run up to 3 machine tools
- Reduced floorspace need
- Higher spindle utilization per machine tool – less machines with a lower initial investment

- 1 Stacker crane**
 - Transports pallets within the system
 - Decreases factory floor forklift traffic
- 2 Cell controller**
 - Control of multiple machine tools
- 3 Ergonomic loading stations**
- 4 Pallet storage**
 - Buffer storage for up to 36 pallets
 - High pallet capacity – high potential for lights-out production



Milling (APC*)



Product category
Milling

Tool automation
No

Other processes
No

Payload
750–3,000 kg

Find out more: fastems.com/product/fpc/



“We have achieved a daily effective machining time of 1,420 minutes, meaning that the machine tool utilization rate is 98.6 percent.”

Managing Director, Sant Hydraulic
fastems.com/case/sant-hydraulic-technology/

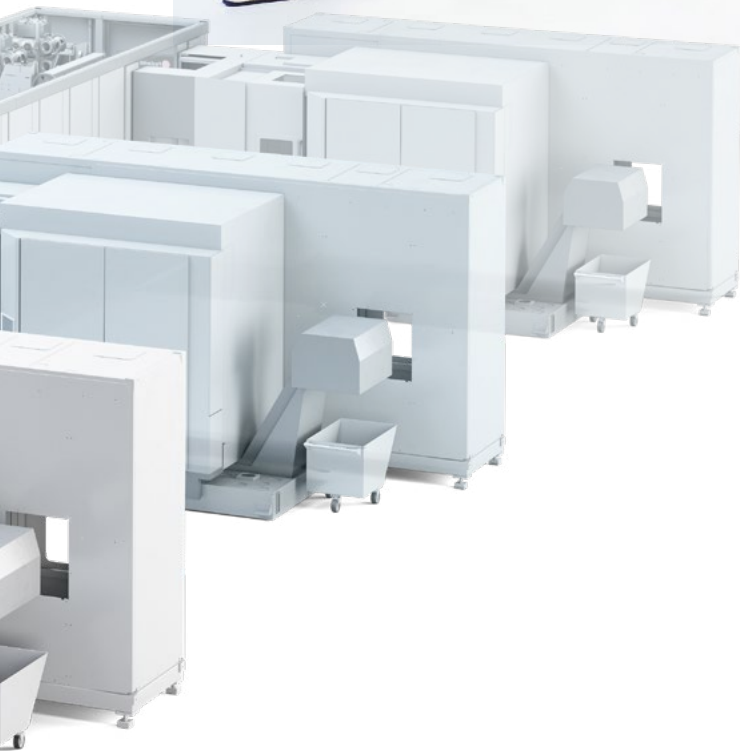

* APC – automatic pallet changer

FPS – Flexible Pallet System

360° Multi-Machine Automation for 4 and 5 Axis

Flexible Pallet System is a modular CNC automation solution that enables lights-out manufacturing and high spindle utilization with 4 and 5 axis milling and mill-turn machine tools of over 90 brands.

1 Pallet manipulator

- 360-degree pallet transportation
- long reach

2 Crane rail

- build the system that fits on your floor
 - a) 6-meter module
 - b) 3-meter module

3 Pallet storage

- configurable for different load heights
- two different heights per system
 - a) side module for 4-8 pallets
 - b) end module for 6-12 pallets

4 Cell controller

- touch operating panel
- ergonomic width adjustable height

5 Loading station

- ergonomic operation
- clamping and unloading the parts
- at a glance system status

6 Machine tool(s)

- with or without automatic pallet changer
- 300 to 630 mm pallets
- over 90 brands already integrated with Fastems

WHAT SETS FPS APART FROM OTHER SOLUTIONS

- State-of-art MMS production planning capabilities for high mix manufacturing
- Share work between machines for high spindle utilization & long unmanned periods
- Modular configuration for maximum space utilization – place machines in all four sides of the system
- Fits into low-ceiling facilities
- Can be extended or upgraded later

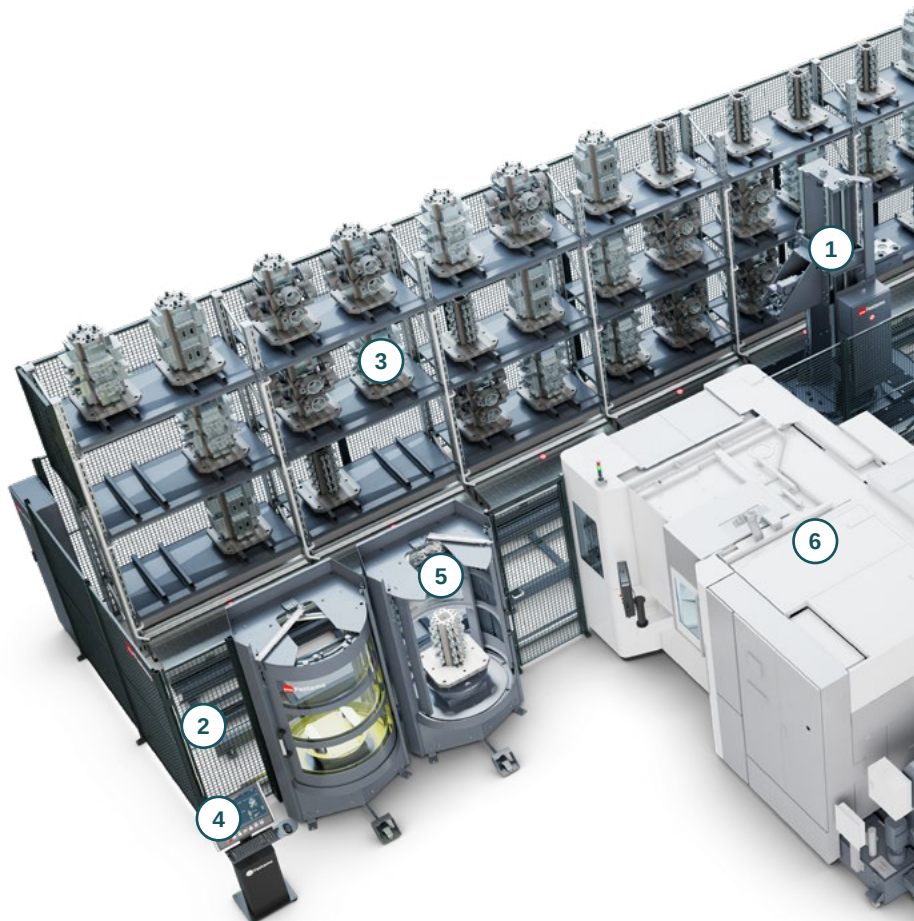

Milling (APC* / no APC*)



Product category
Milling

Tool automation
No

Other processes
No

Payload
500–1,000 kg

Find out more: fastems.com/product/fps

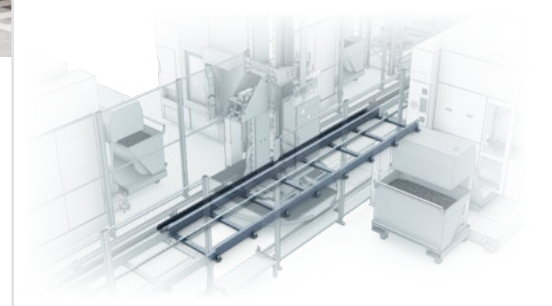
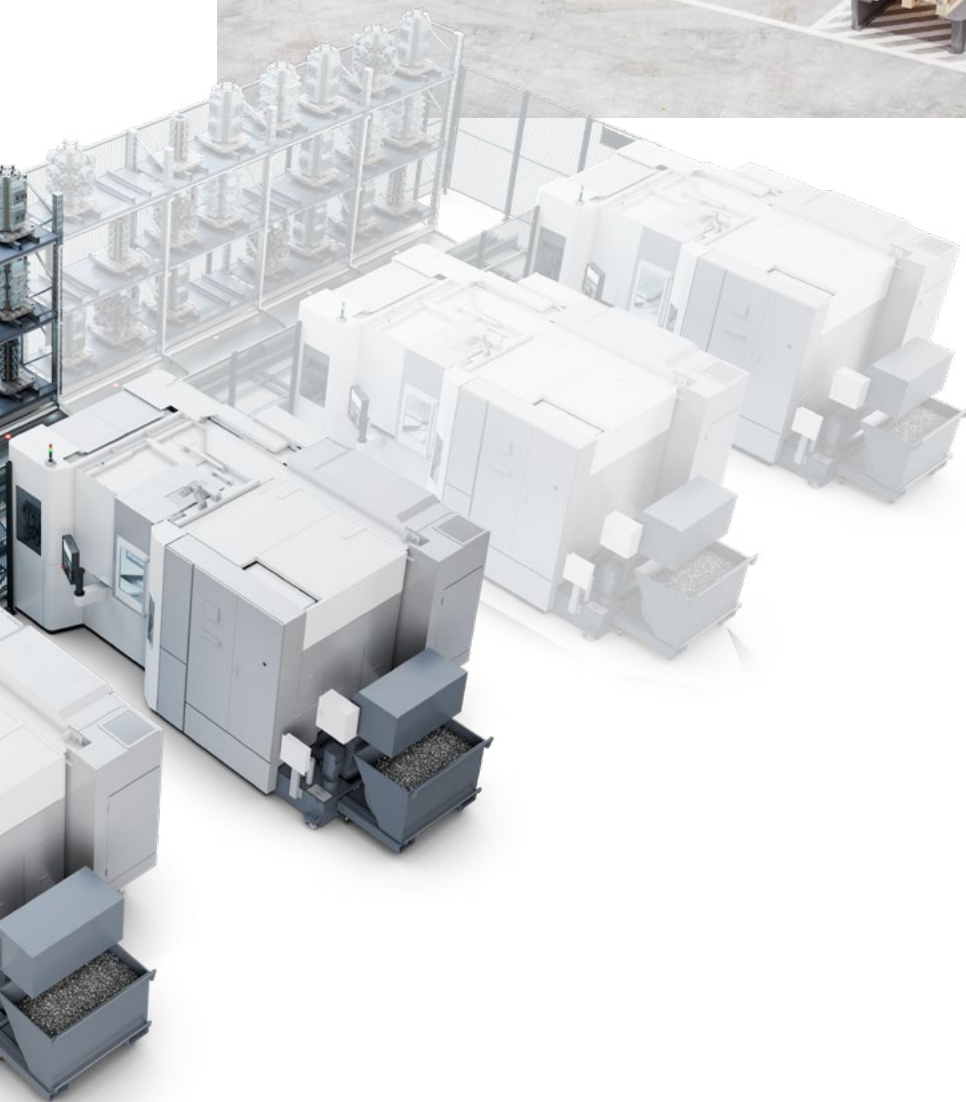

* APC – automatic pallet changer

MLS - Multi-Level System

Customized FMS for Advanced Process Integration

Fastems MLS is a modular, scalable and customizable FMS for any need. It can integrate even tens of machine tools together - combining also different machine tool types in the same system.

MLS handles even the most demanding and complex manufacturing settings. This includes managing tools, finishing processes, CMM, automatic fixture loading, washing and surface treatments.. MLS comes with a wide range of loading and material stations to ensure safe and ergonomic operation with any workpiece, and is able to handle extremely heavy payloads.

MLS BENEFITS

- Excellent floor-space utilization
- Automation solution for every 3 to 5 axis machine tool
- Easy and straightforward extendability
- Extended lights-out manufacturing
- High pallet transfer per hour -capacity
- Integrated material management
- Multiple machine tool types in the same system – also non-APC*
- Ready for robotic applications

- 1 Stacker crane**
 - Transports pallets within the system
 - Decreases factory floor forklift traffic
- 2 2–5 level pallet and material storage**
 - Storage for machining and material pallets
 - High pallet capacity
 - Potential for long lights-out periods
- 3 Cell controller**
 - Control of multiple machine tools
- 4 Loading station**
 - Part and fixture setups
 - Variety of ergonomic options
- 5 Material station**
 - Input of raw materials
 - For different material pallet sizes
- 6 Machine tool**
 - 3 to 5 axis milling and mill-turn MCs
 - - also turning machines possible
 - - from 400mm pallet or zero-point plate upwards

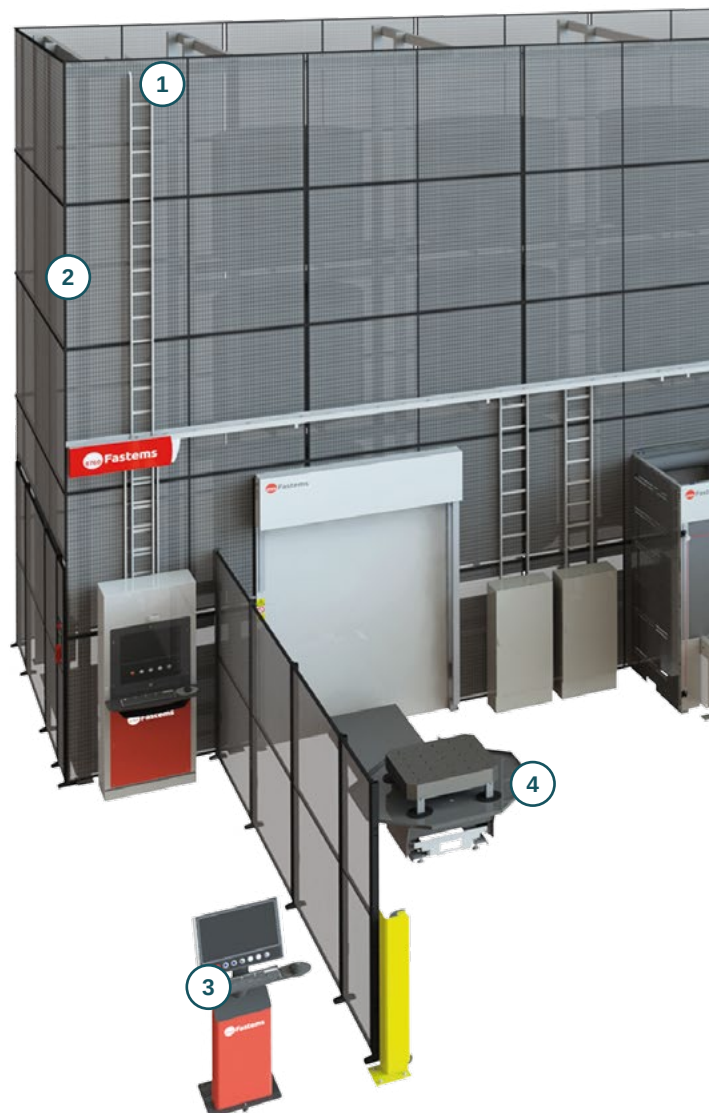

Milling (APC*/no APC*)



Product category
Milling

Tool automation
Yes

Other processes
Yes

Payload
500–11,000 kg

Find out more: fastems.com/product/mls/

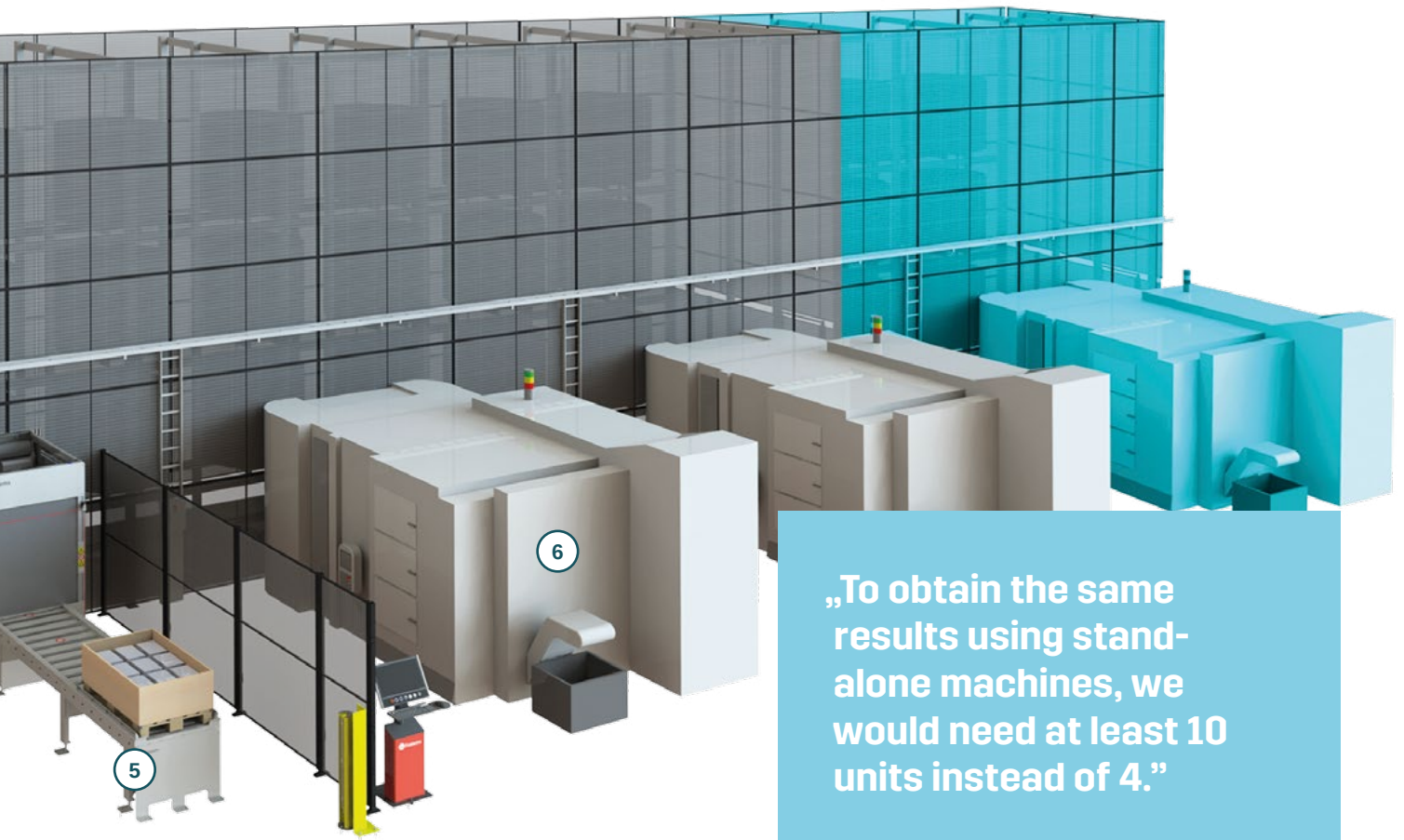

„To obtain the same results using stand-alone machines, we would need at least 10 units instead of 4.”

CEO, A. Abete Srl
fastems.com/case/a-abete-srl/

* APC – automatic pallet changer

RoboFMS

Extreme Flexibility for Machines without APC

Fastems RoboFMS combines the benefits of an industrial robot and flexible manufacturing system. It brings new flexibility to automating machine tools, especially those with zero-point plates or those without automatic pallet changers.

Like most of Fastems FMS, RoboFMS can be extended later with more machine tools, and non-machining operations such as washing, finishing, marking or measuring can be integrated in a simple and cost effective way.

ROBOFMS BENEFITS

- Pallet automation for new-generation 5-axis universal mills and vertical milling machines
- Zero-point pallet handling
- Multiple machine tool types in the same system
- Pallet handling possible for machine tools that don't have APC
- Extendable system

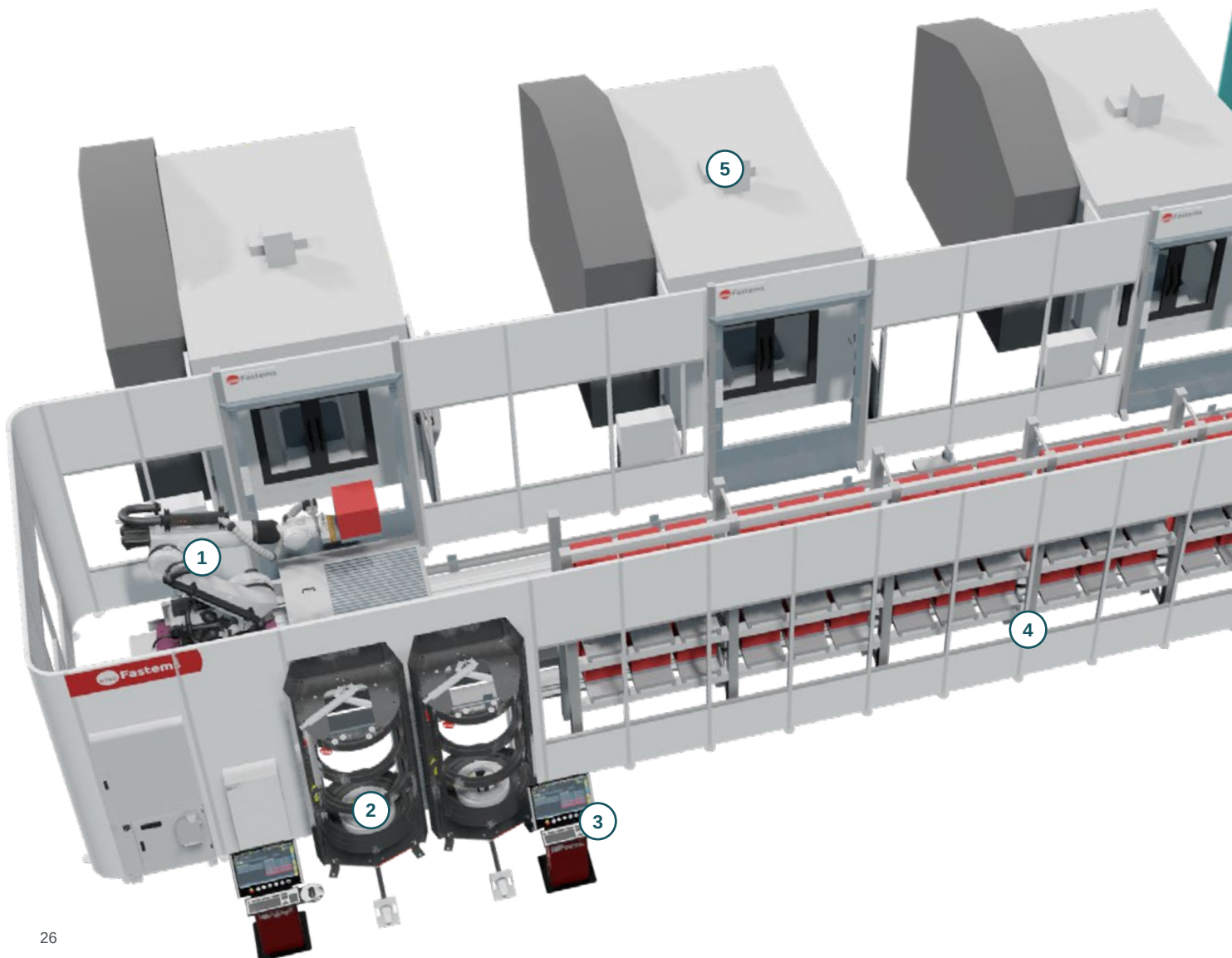

Milling (no APC*)



Product category
Milling

Tool automation
Yes

Other processes
Yes

Payload
0–1,000 kg

Find out more: fastems.com/product/robofms/

- 1 Robot**
 - Transfers pallets within the system
- 2 Loading station**
 - Part and fixture setups
- 3 Cell controller**
 - Control of multiple machine tools
- 4 Storage modules**
 - Compact and spacious
- 5 Machine tools**
 - with direct loading
 - pallets or zero-point plates up to 800mm

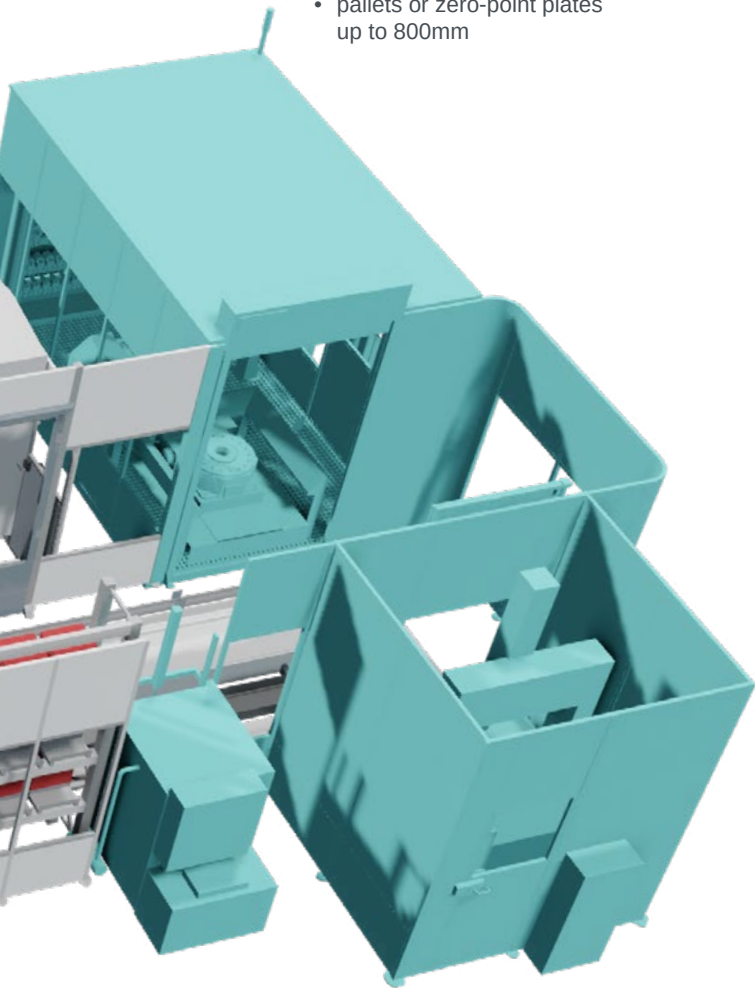

“We are now able to produce for an entire weekend unmanned, even in batch sizes of 1.”

Global Process Development Manager,
SKF Aeroengine fastems.com/case/skf-aeroengine-france/

* APC – automatic pallet changer

Loading and Material Stations for FMS

For Any Workpiece

	LST	LSL	LSM	LSC	LSB	LSS	MSB	MSC	MSP	IOC
FPC				○	○	○				
MLS	○	○	○	○	○	○	○	○	○	○
RoboFMS				○		○				



LST | Tilting loading station

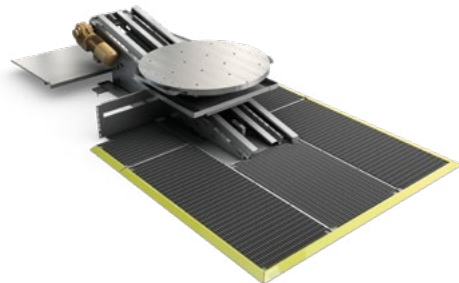

LSL | Lifting loading station

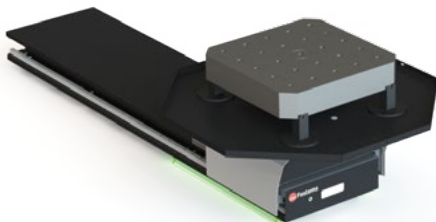

LSM | Moving loading station



LSC | Compact loading station

Flexible Manufacturing Systems

Product category
Milling

Tool automation

—

Other processes

—

Payload

—

ERGONOMICAL WORK ENVIRONMENT FOR EVERYONE

The operator's work area is the heart of the FMS operation. Fastems provides a variety of loading and material stations for ergonomic and efficient manual operations. Feel free to select the type that complements your fixturing and workpieces,

while also minimizing unnecessary work. All loading stations can also be equipped with automatic, hydraulic or vacuum powered feed-through for automated workholding. The iconic Fastems Touch OP complements the loading cell and puts the operator in control. These stations can also be installed to the system afterwards as a modification when your manufacturing needs to evolve.



LSB | Basic Loading Station



LSS | Stationary Loading Station

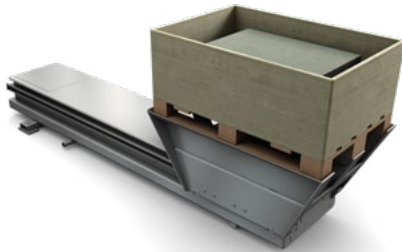

MSB | Basic material station



MSC | Conveyor material station



MSP | Picking material station

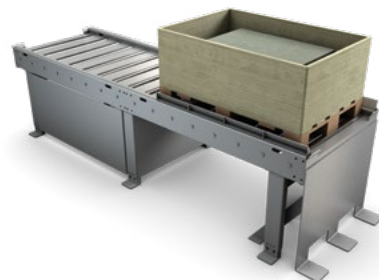

IOC | In-out-conveyor material station

Turning / Milling (no APC*)

Product category
Turning

Tool automation
Yes

Other processes
Yes

Payload
1–1,000 kg



Find out more: fastems.com/product/amc/

AMC – Agile Manufacturing Cell

For Cost Effective Manufacturing of Small Batches

Fastems Agile Manufacturing Cell is a solution for order driven, flexible batch manufacturing of several different parts up to several product families. AMC is a partly modular solution that can be customized for very different needs, making production efficient from batch size of one to large batches of thousands.

AGILE MANUFACTURING CELL BENEFITS

- It is an agile automation of one or more machine tools with a single robot
- Long unmanned periods through extended storage and automatic batch change over
- Indication of required user actions and resource need for minimized system downtime
- Integration of auxiliary manufacturing processes for increased added value
- Possibility to run in several different machine sequences on the machine tool depending on the part
- Freely configurable part route in cell and parametric part handling programming



“At the moment, our robot cell runs at a capacity of 90 percent, producing 32 different components unmanned in 2 ghost shifts.”

Operations Manager, ALLMATIC
fastems.com/case/allmatic-jakob-spansysteme/

Turning / Milling (no APC*)

Product category
Turning

Tool automation
Yes

Other processes
Yes

Payload
1–1,000 kg

AMS – Agile Manufacturing System

For Extensively Integrated Manufacturing Processes

AMS is a customized and factory wide software and hardware solution for automating complete manufacturing chains. It can consist of any configuration of Fastems automation hardware and unautomated machines, and they are all controlled with MMS.

AGILE MANUFACTURING SYSTEM BENEFITS

- Factory level control for the manufacturing process
- Short lead times as the control constantly pushes the produced part forward in the manufacturing chain
- Clear overview of the current manufacturing situation
- Possibility to predict the future workload based on the current order statuses
- Integrations to top level IT systems done only once
- Clear overview of the current amount of WIP parts
- Automates the fine planning for the whole factory

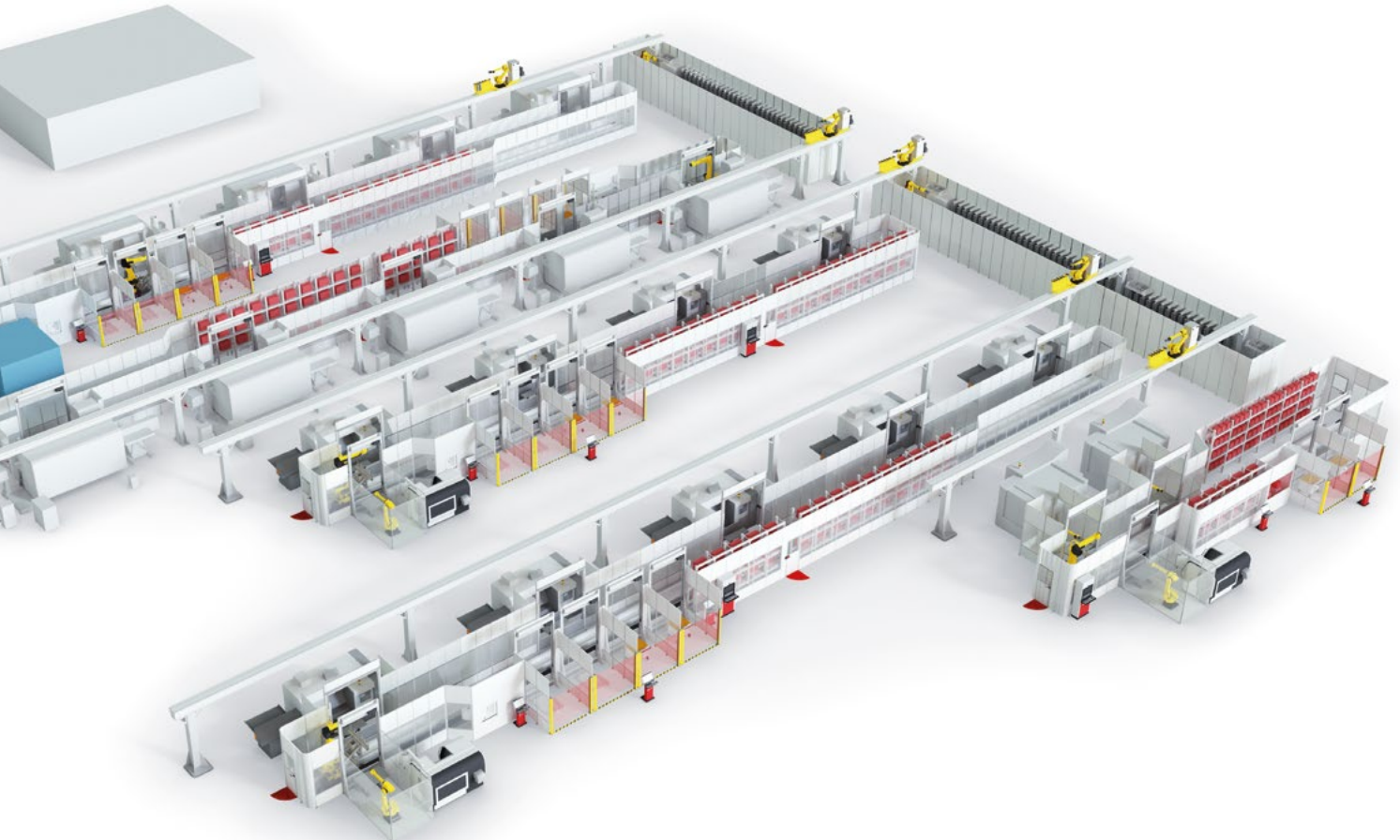

GTS – Gantry Tool Storage & CTS – Central Tool Storage

Further Utilization for High Tool Consumption

Fastems tool automation solutions give visibility over coming tool needs, reduce tool loading errors and spindle breaks, and automate tool set up changes, replacement of worn-out tools and tool sharing between many machines. Tool automation can increase machine tool utilization even above 95% while reducing the need for sister tooling and large machine tool magazines.

TOOL AUTOMATION BENEFITS

- Know in advance which tool is needed, where and when
- Consistent quality and zero spindle breaks with no tool loading errors
- Long unmanned periods and even above 95% machine tool utilization
- Reduced need for sister tools
- Smaller machine tool magazines needed

1 Centralized tool storage

- Can be positioned on the floor or to save floorspace, on a gantry above machine tools

2 Industrial robot

- Transfers tools between machines and the centralized tool magazine
- Can move 3/5 tools at once

3 Tool lift

- For bringing the broken or worn out tools to setup

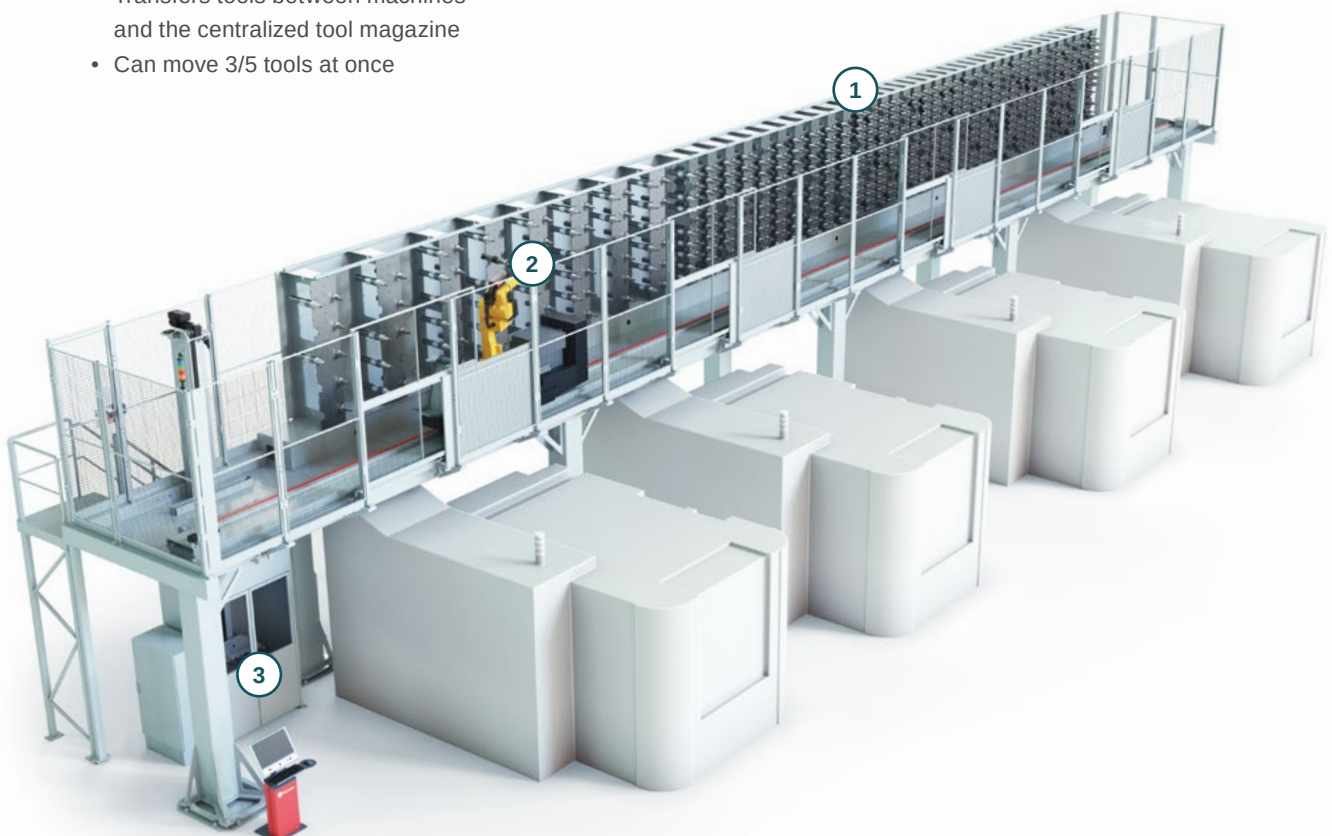

Other processes



Product category
Tool handling

Tool automation

Other processes

Payload

Find out more: fastems.com/product/toolautomation/

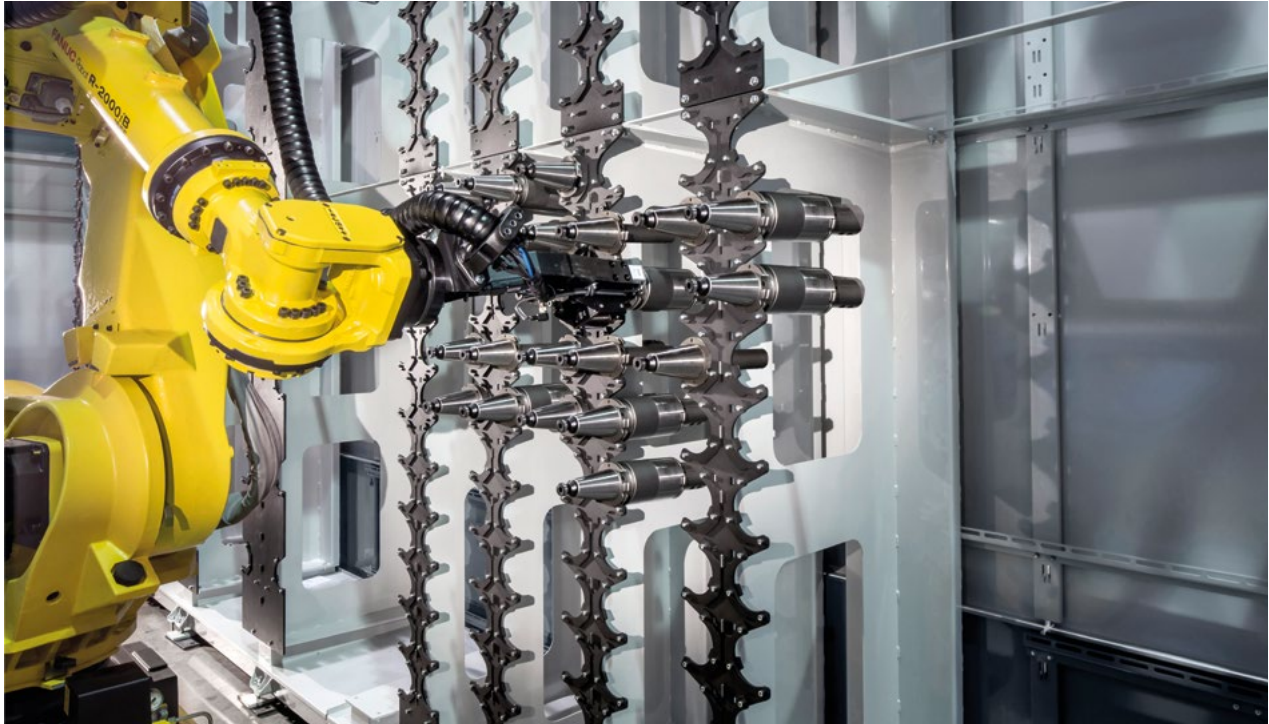

“Our retooling times are 0.0 minutes, which means that every component always has the same price for our customers, regardless of whether they order ten of them or a hundred.”

CEO, Kempf CNC-Technik
fastems.com/case/kempf-cnc-technik/

TSC – Tool Service Cell

Save Time from Tool Setups

If the tool lives are extremely short and demand for renewed tools is high, tool automation can be extended to optimize the tool setup process. Tool Service Cell (TSC) integrates with centralized tool storage, and makes tool reworking significantly faster, reduces need for manual work and improves operator ergonomics even further.

TSC – TOOL SERVICE CELL BENEFITS

- timely and automated tool reworking
- save time from manual work
- great ergonomics without heavy lifts
- integrates with GTS/CTS - automatic delivery and return of tools needing a rework

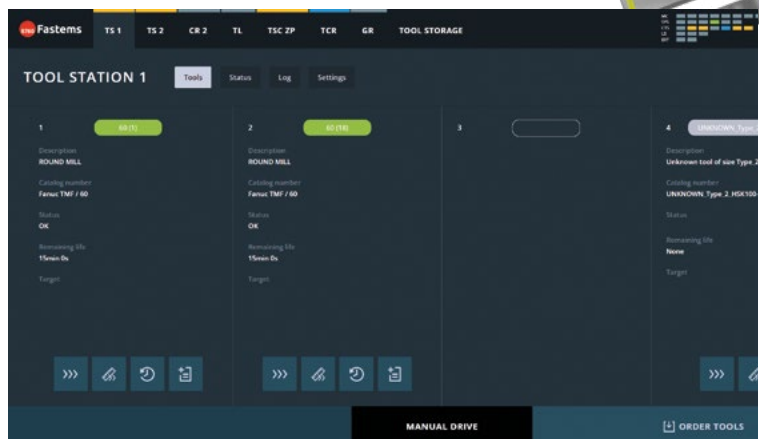
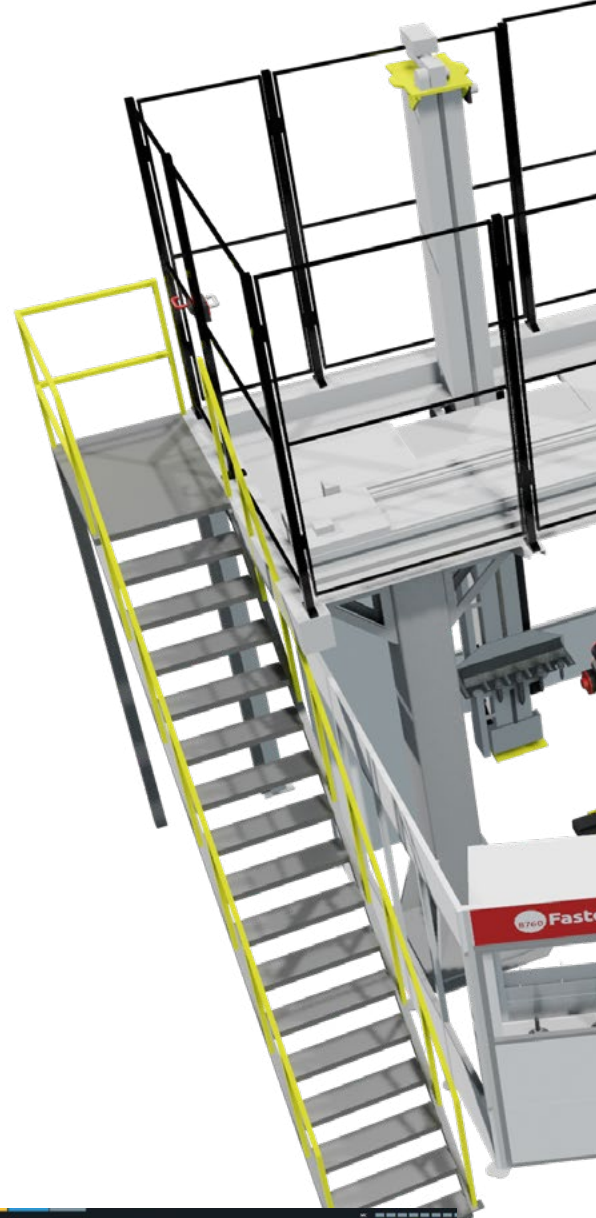

Other processes



Product category
Tool handling

Tool automation
—

Other processes
—

Payload
—

Find out more: fastems.com/product/tool-service-cell/

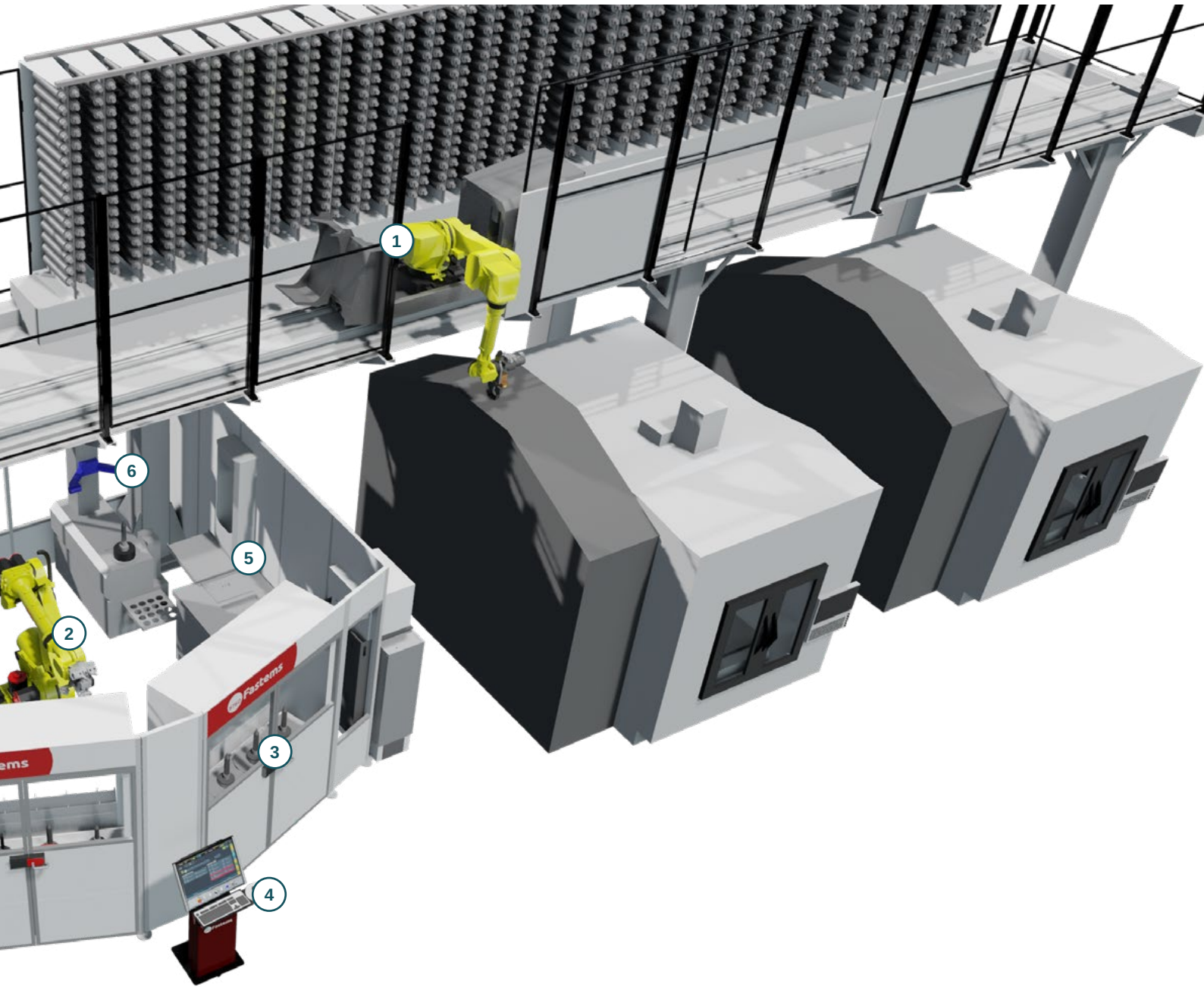

AT A GLANCE

- 1 Centralized Tool Storage system delivers tools automatically to Tool Service Cell
- 2 Industrial robot moves tools through the reworking process
- 3 Tool loading station allows ergonomical and fast tool inserting for up to 4 tools at once
- 4 MMS calculates and guides the optimal order for tool reworking
- 5 Washing and drying
- 6 Tool presetter

Product category
Finishing

Tool automation
—

Other processes
—

Payload
—



Find out more: fastems.com/product/rfc/

RFC – Robotic Finishing Cell

Next Level Quality with Automated Finishing

Fastems Robotic Finishing Cell (RFC) automates your grinding, polishing, deburring and other finishing processes. This means stable quality, smooth processes and lower costs.

WHY CHOOSE FASTEMS RFC?

- Modular solutions available for FMS integrated or standalone use
- Large variety of process tools can be implemented – both pneumatic and electric
- Tool lifetime tracking through MMS technologies
- Constantly higher quality with standardized finishing processes
- Improved safety and ergonomics for finishing operators
- Longer lights-out operation and increased productivity

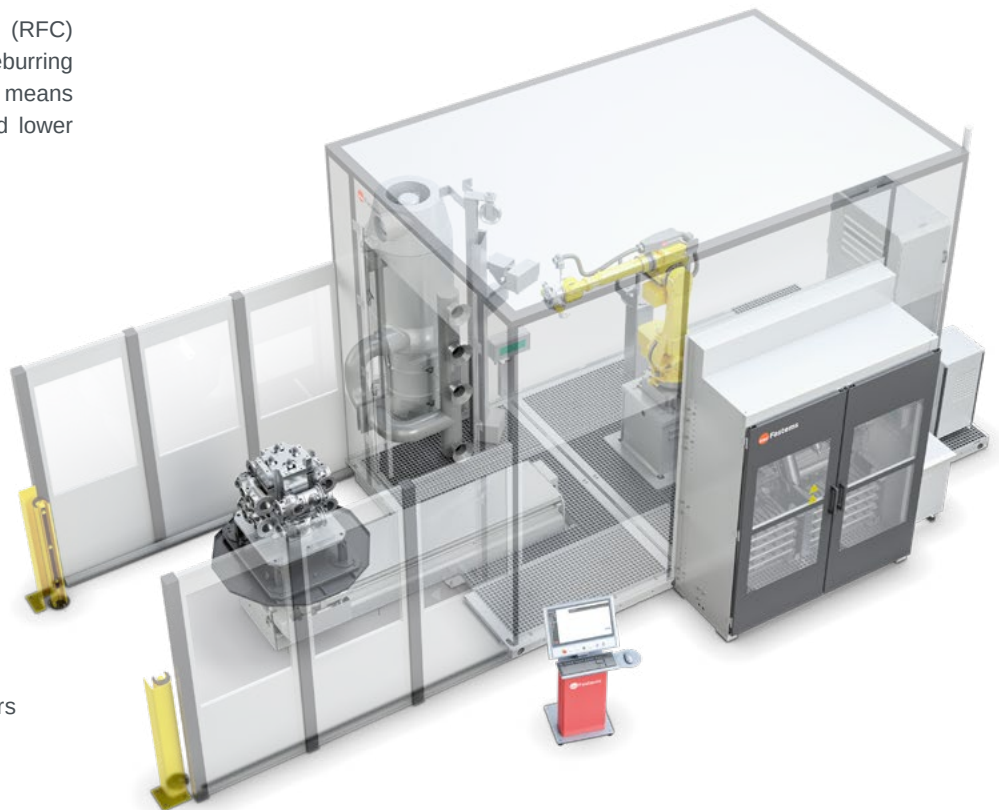

ROBOTIC DEBURRING SERVICES

- Professional analysis how to automate your deburring process
- Evaluate the quality and automation level of your workpiece with test services using our RFC test center located in Finland

FASTSIMU

– OFFLINE ROBOT PROGRAMMING

- Easy new workpiece programming
- Realistic simulation of work cycles
- Significantly reduced on-line programming time

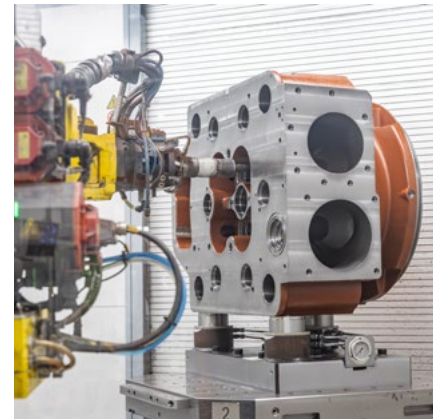
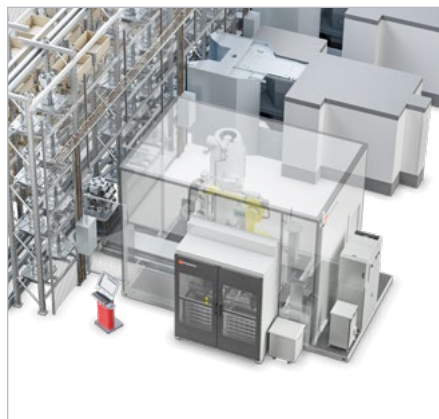



Find out more: fastems.com/product/ald/

ALD – Auto Loading Cell

For Highly Automated Production

WANT TO UNLEASH THE FULL POTENTIAL OF YOUR FMS?

Fastems ALD optimizes your production through automated raw material loading and ready part unloading with a robot. This improves quality and lengthens unmanned production periods while bringing cost savings by reducing the number of fixtures.

WHY INTEGRATE AUTOMATED LOADING INTO YOUR FMS?

- Produce full nights and weekends unmanned
- Lower capital tied in pallets and fixtures
- Machine tool spindle utilization of up to 95%

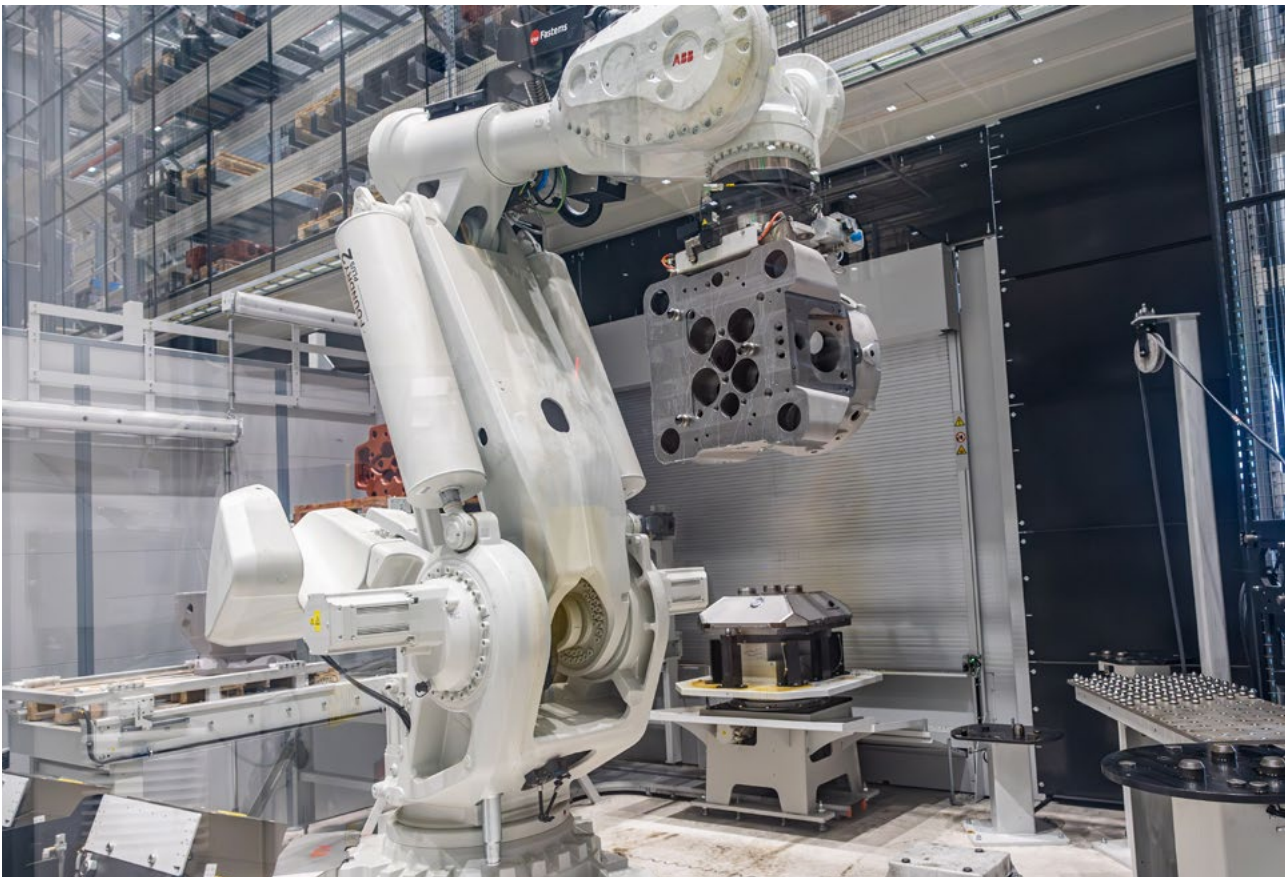
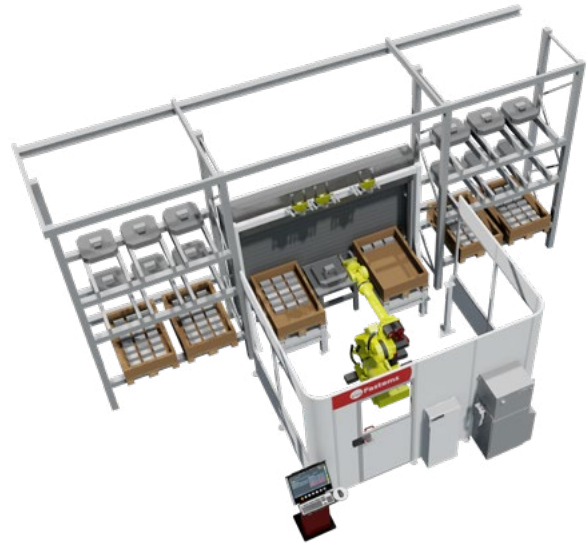

Plan Your System

Our mission is your success in automated high-mix manufacturing



„Fastems really is committed to giving us not just a piece of hardware but something that’s going to help us take the next step.“

Manufacturing Technology Lead of Lockheed Martin, North America

“The capacity of two automated HMCs is comparable to that of 10 unpalletized VMCs.”

President of a job shop, North America

“We basically doubled our production output with the same number of employees.”

Founder of a forestry equipment manufacturer, North America

“We can produce sophisticated components in the required quantities and the highest quality, within the agreed deadlines.”

Process Engineering Manager of SKF, Europe

“At the same time, the amount of overtime and sick leaves has decreased, and the staff is more committed and coping better.“

CEO of a subcontractor, Europe

„And all this comes with a ROI time for the automation of less than two years!“

CEO of an instrument manufacturer, Europe



These and more case stories at fastems.com/cases